

S 976W ..

Ø 21-50

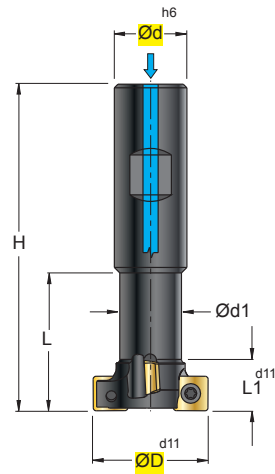

SPHT ...
.A57P



SPMW..
.A51



SPMW..
.A52



SPMT..
.A53



SPMT ...
.A56



INSERTI - INSERTS
PAG. B 271

(mm)

ART.	ØD	Ød	Ød1	H	L	L1	Z	K	kg	Nm			
S 976W 021-06	21	16	11	76	24	9	2	1	0,10	1,1+1,3	060304	12256P	5608P
S 976W 025-06	25	16	13	82	28	11	4	2	0,11	1,1+1,3			
S 976W 032-09	32	20	17	88	35	14	4	2	0,15	3,0+3,5	09T308	123509P	5615P
S 976W 040-09	40	25	21	108	44	17	4	2	0,37	3,0+3,5			
S 976W 050-12	50	32	27	120	59	21	4	2	0,65	4,0+5,0	120408	124510	5620

NOTE:

- Per cave a "T" secondo norme DIN 650-UNI 4788-ISO 299
- For "T" slot cutters according to DIN 650-UNI 4788-ISO 299 norms
- Fuer "T" Nuten nach DIN 650-UNI 4788-ISO 299 Normen
- Pour rainures à "T" selon les normes DIN 650-UNI 4788-ISO 299

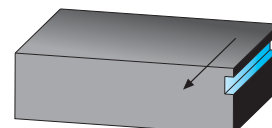
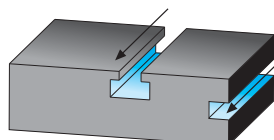

Z = Numero di eliche - Number of flutes - Spiralenanzahl - Nombre d' helices
 K = Fattore d' avanzamento - Factor of feed - Vorschubfaktor - Facteur d' avance
 W = Foro per liquido refrigerante - Coolant bore - Kühlmittelbohrung - Trou du liquide d'arrosage



SCelta VELOCE - QUICK PICK



COD.	P			M			K			N			S			H			HT	HW	HC				l	d	s	d1	r	a°	
	F	M	R	F	M	R	F	M	R	F	M	R	F	M	R	F	M	R			CERMET	N3415	T510	T525							T540
SPHT 060304 .A57P										●	●	●	●	●	●									6,35	6,35	3,18	2,8	0,4	11		
SPHT 09T308 .A57P										●	●	●	●	●	●									9,52	9,52	3,97	4,5	0,8	11		
SPHT 120408 .A57P										●	●	●	●	●	●									12,7	12,7	4,76	5,5	0,8	11		
SPMW 060304 .A51	○	●	○				●	●	●												■			6,35	6,35	3,18	2,8	0,4	11		
SPMW 09T308 .A51	○	●	○				●	●	●												■			9,52	9,52	3,97	4,5	0,8	11		
SPMW 120408 .A51	○	●	○				●	●	●												■			12,7	12,7	4,76	5,5	0,8	11		
SPMW 060304T .A52	○	●	○	○	○	○								○	○							■	■	6,35	6,35	3,18	2,8	0,4	11		
SPMW 09T308T .A52	○	●	○	○	○	○								○	○							■	■	9,52	9,52	3,97	4,5	0,8	11		
SPMW 120408T .A52	○	●	○	○	○	○								○	○							■	■	12,7	12,7	4,76	5,5	0,8	11		
SPMT 060304 .A53	●	●	○	●	●	○					●	○		●	○							■	■	6,35	6,35	3,18	2,8	0,4	11		
SPMT 09T308 .A53	●	●	○	●	●	○					●	○		●	○							■	■	9,52	9,52	3,97	4,5	0,8	11		
SPMT 120408 .A53	●	●	○	●	●	○					●	○		●	○							■	■	12,7	12,7	4,76	5,5	0,8	11		
SPMT 060304 .A56	○	●	○				●	●	●												□			6,35	6,35	3,18	2,8	0,4	11		
SPMT 09T308 .A56	○	●	○				●	●	●												□			9,52	9,52	3,97	4,5	0,8	11		
SPMT 120408 .A56	○	●	○				●	●	●												□			12,7	12,7	4,76	5,5	0,8	11		

CON ADDUZIONE LUBROREFRIGERANTE - WITH COOLANT SUPPLY

SENZA ADDUZIONE LUBROREFRIGERANTE - WITHOUT COOLANT SUPPLY

MATERIALI - MATERIALS Pag. H 73		VDI 3323 GR.	HB Rm1) HRC2)	fz0 mm			Vc m/min Pag. B 254						
				F	M	R	T510	N3415	T525	T540			
P	ACCIAIO NON LEGATO - NOT ALLOY STEEL	1-5	125-300	0,1	0,15	0,2	270		250	180			
	ACCIAIO POCO LEGATO - LOW ALLOY STEEL	6-9	180-350	0,06	0,1	0,15	210		200	140			
	ACCIAIO ALTO LEGATO - ALLOY STEEL	10-11	200-325	0,06	0,1	0,15	170		170	100			
	INOX MARTENS. - STAINLESS STEEL MART	12-13	200-240	0,06	0,08	0,12				130			
M	INOX AUST. DUPLEX - STAINLESS STEEL AUST	14.1-14.2	180-230	0,06	0,08	0,12			200	120			
K	GHISA GRIGIA - GREY CAST IRON	15-16	180-260	0,1	0,15	0,2	250		200				
	GHISA SFEROIDALE - SPHEROIDAL GRAPHITE	17-18	160-250	0,08	0,12	0,16	200		180				
	GHISA MALLEABILE - MALLEABLE CAST IRON	19-20	130-230	0,08	0,12	0,16	220		200				
N	ALLUMINIO E SUE LEGHE - ALUMINIUM	21-25	60-130	0,08	0,15	0,2		600					
	RAME E SUE LEGHE - COPPER	26-28	90-110	0,06	0,1	0,18		300					
	NON METALLICI - PLASTICS	29-30	/	0,06	0,1	0,18		950					
S	LEGHE RESIST. CALORE - HIG. TEMP. ALLOY	31-35	200-320	0,06	0,08	0,12			40	50			
	TITANIO E SUE LEGHE - TITANIUM	36-37	400-1050 ^b	0,06	0,08	0,12			60	50			
H	ACCIAIO TEMPRATO - HARDENED STEEL	38-41	45-60 ^a	0,06	0,08	0,12	40		40				

$$n = \frac{Vc \cdot 1000}{\phi D \cdot 3,14} = \text{giri/min (min}^{-1}\text{)}$$

$$fz = fz0 \cdot Kae = \text{mm}$$

$$fn = fz \cdot K = \text{mm}$$

$$Vf = fz \cdot K \cdot n = \text{mm/min}$$

- F = FINITURA, LAV. LEGGERA - FINISHING, LIGHT MACHINING
- M = LAV. MEDIA, GENERICA - MEDIUM MACHINING, GENERIC
- R = SGROSSATURA, LAV. PESANTE - ROUGHING, HEAVY MACHINING

- Vc = m/min VELOCITÀ DI TAGLIO - CUTTING SPEED
- n = giri/min (min⁻¹) NUMERO DI GIRI - NUMBER OF REVOLUTIONS
- fz = mm AVANZAMENTO AL DENTE - TOOTH FEED
- fn = mm AVANZAMENTO AL GIRO - FEED / REVOLUTION
- Vf = mm/min VELOCITÀ DI AVANZAMENTO - FEED SPEED
- Kae = FATTORE DI CORREZIONE - CORRECTION FACTOR

	1°	2°	3°
ae/D	1	0,5	0,2
ae/D	100%	50%	20%
Kae	1	1	1,5

ae/D	0,5-1 50-100%	0,2 20%	0,1 10%	0,05 5%
Vc	Vc (min)-----Vc(max)			
Pag. B 254	R-----M-----F			

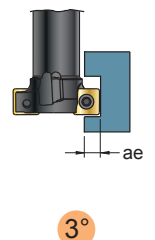
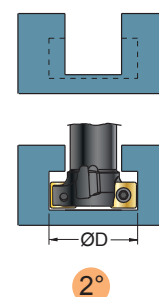
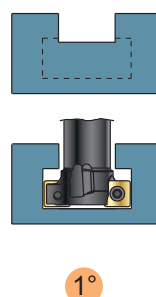

S 950 ..

Ø 63-250

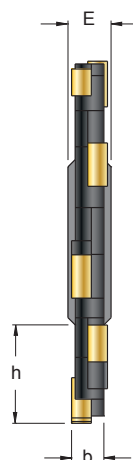
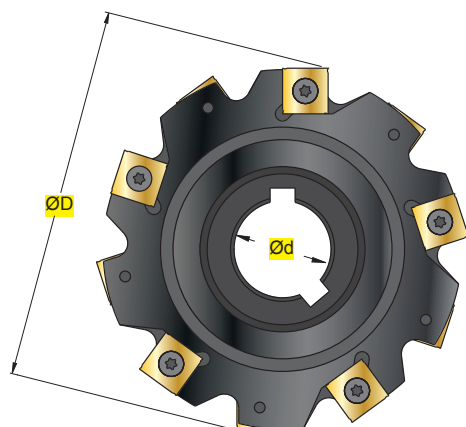

SNHX..
.Z47



SNHX..
.Z52



SNHX..
.Z62



INSERTI - INSERTS
PAG. B 270

ART.		(mm)							kg	Nm			
		ØD	Ød	h	b	E	Z	K					
S 950	063 - 04	63	22	14	4	8	8	4	0,06	1,8+2,0	1102	C93504	5609
S 950	063 - 05	63	22	14	5	8	8	4	0,07	1,8+2,0	1103	C93505	5609
S 950	063 - 06	63	22	14	6	8	6	3	0,07	2,0+2,2	1203	C94005	5615
S 950	080 - 04	80	22	22	4	8	10	5	0,10	1,8+2,0	1102	C93504	5609
S 950	080 - 05	80	22	22	5	8	10	5	0,12	1,8+2,0	1103	C93505	5609
S 950	080 - 06	80	22	22	6	8	8	4	0,13	2,0+2,2	1203	C94005	5615
S 950	100 - 04	100	27	25	4	12	12	6	0,20	1,8+2,0	1102	C93504	5609
S 950	100 - 05	100	27	25	5	12	12	6	0,23	1,8+2,0	1103	C93505	5609
S 950	100 - 06	100	27	25	6	12	10	5	0,26	2,0+2,2	1203	C94005	5615
S 950	100 - 07/08	100	27	25	7/8	12	10	5	0,30	2,0+2,2	1204/12045	C94006	5615
S 950	100 - 10	100	27	25	10	12	10	5	0,37	2,0+2,2	1205	C94008	5615
S 950	125 - 04	125	40	31	4	12	12	6	0,31	1,8+2,0	1102	C93504	5609
S 950	125 - 05	125	40	31	5	12	12	6	0,35	1,8+2,0	1103	C93505	5609
S 950	125 - 06	125	40	31	6	12	12	6	0,40	2,0+2,2	1203	C94005	5615
S 950	125 - 07/08	125	40	31	7/8	12	12	6	0,45	2,0+2,2	1204/12045	C94006	5615
S 950	125 - 10	125	40	31	10	12	12	6	0,57	2,0+2,2	1205	C94008	5615
S 950	125 - 12	125	40	31	12	12	12	6	0,67	2,0+2,2	1207	C94010	5615
S 950	160 - 04	160	40	44	4	12	18	9	0,56	1,8+2,0	1102	C93504	5609
S 950	160 - 05	160	40	44	5	12	18	9	0,64	1,8+2,0	1103	C93505	5609
S 950	160 - 06	160	40	44	6	12	16	8	0,74	2,0+2,2	1203	C94005	5615
S 950	160 - 07/08	160	40	44	7/8	12	16	8	0,82	2,0+2,2	1204/12045	C94006	5615
S 950	160 - 10	160	40	44	10	12	16	8	1,03	2,0+2,2	1205	C94008	5615
S 950	160 - 12	160	40	44	12	12	16	8	1,30	2,0+2,2	1207	C94010	5615
S 950	160 - 14	160	40	44	14	14	15	5	1,50	2,0+2,2	1205	C94008	5615
S 950	200 - 04	200	50	62	4	12	18	9	0,76	1,8+2,0	1102	C93504	5609
S 950	200 - 05	200	50	62	5	12	18	9	0,89	1,8+2,0	1103	C93505	5609
S 950	200 - 06	200	50	62	6	12	18	9	1,10	2,0+2,2	1203	C94005	5615
S 950	200 - 07/08	200	50	62	7/8	12	18	9	1,30	2,0+2,2	1204/12045	C94006	5615
S 950	200 - 10	200	50	62	10	12	18	9	1,70	2,0+2,2	1205	C94008	5615
S 950	200 - 12	200	50	62	12	12	18	9	2,00	2,0+2,2	1207	C94010	5615
S 950	200 - 14	200	50	62	14	14	18	6	2,40	2,0+2,2	1205	C94008	5615
S 950	250 - 10	250	50	87	10	12	24	12	2,70	2,0+2,2	1205	C94008	5615
S 950	250 - 12	250	50	87	12	12	20	10	3,40	2,0+2,2	1207	C94010	5615

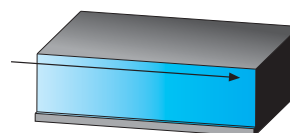
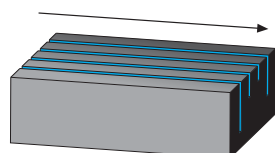

K = Fattore d'avanzamento - Factor of feed - Vorschubfaktor - Facteur d'avance

S 955 ..

Ø 50-160

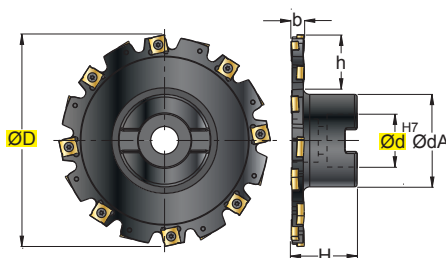
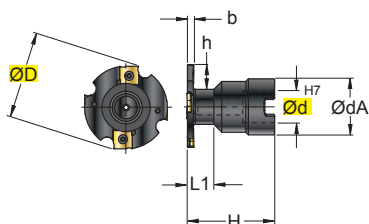

Ø50

Ø63÷Ø160

SNHX.. .Z47	
SNHX.. .Z52	
SNHX.. .Z62	
INSERTI - INSERTS PAG. B 270	

ART.	(mm)										kg	Nm	ISO 6462					
	ØD	Ød	b	ØdA	H	L1	h	Z	K									
S 955 050 - 04	50	16	4	32	50	15	8,5	4	2	0,20	1,8÷2,0	-	1102	C93504	5609	VDST2008	-	
S 955 050 - 05	50	16	5	32	50	15	8,5	4	2	0,21	1,8÷2,0	-	1103	C93505	5609	VDST2008	-	
S 955 050 - 06	50	16	6	32	50	15	8,5	4	2	0,21	2,0÷2,2	-	1203	C94005	5615	VDST2008	-	
S 955 050 - 07/08 <i>New</i>	50	16	7/8	32	50	15	8,5	4	2	0,22	2,0÷2,2	-	1204/12045	C94006	5615	VDST2008	-	
S 955 050 - 10 <i>New</i>	50	16	10	32	50	15	8,5	4	2	0,25	2,0÷2,2	-	1205	C94008	5615	VDST2008	-	
S 955 050 - 12 <i>New</i>	50	16	12	32	50	15	8,5	4	2	0,26	2,0÷2,2	-	1207	C94010	5615	VDST2008	-	
S 955 063 - 04	63	22	4	40	50	-	10,5	8	4	0,34	1,8÷2,0	A	1102	C93504	5609	-	AL10x40	
S 955 063 - 05	63	22	5	40	50	-	10,5	8	4	0,35	1,8÷2,0	A	1103	C93505	5609	-	AL10x40	
S 955 063 - 06	63	22	6	40	50	-	10,5	6	3	0,35	2,0÷2,2	A	1203	C94005	5615	-	AL10x40	
S 955 063 - 07/08 <i>New</i>	63	22	7/8	40	50	-	10,5	6	3	0,37	2,0÷2,2	A	1204/12045	C94006	5615	-	AL10x40	
S 955 063 - 10 <i>New</i>	63	22	10	40	50	-	10,5	6	3	0,39	2,0÷2,2	A	1205	C94008	5615	-	AL10x40	
S 955 063 - 12 <i>New</i>	63	22	12	40	50	-	10,5	6	3	0,40	2,0÷2,2	A	1207	C94010	5615	-	AL10x40	
S 955 063 - 14 <i>New</i>	63	22	14	40	50	-	10,5	6	2	0,43	2,0÷2,2	A	1205	C94008	5615	-	AL10x40	
S 955 063 - 16 <i>New</i>	63	22	16	40	50	-	10,5	6	2	0,45	2,0÷2,2	A	1207	C94008	5615	-	AL10x40	
S 955 080 - 04	80	22	4	40	50	-	20	10	5	0,38	1,8÷2,0	A	1102	C93504	5609	-	AL10x40	
S 955 080 - 05	80	22	5	40	50	-	20	10	5	0,40	1,8÷2,0	A	1103	C93505	5609	-	AL10x40	
S 955 080 - 06	80	22	6	40	50	-	20	8	4	0,41	2,0÷2,2	A	1203	C94005	5615	-	AL10x40	
S 955 080 - 07/08 <i>New</i>	80	22	7/8	40	50	-	20	8	4	0,44	2,0÷2,2	A	1204/12045	C94006	5615	-	AL10x40	
S 955 080 - 10 <i>New</i>	80	22	10	40	50	-	20	8	4	0,49	2,0÷2,2	A	1205	C94008	5615	-	AL10x40	
S 955 080 - 12 <i>New</i>	80	22	12	40	50	-	20	8	4	0,53	2,0÷2,2	A	1207	C94010	5615	-	AL10x40	
S 955 080 - 14 <i>New</i>	80	22	14	40	50	-	20	6	2	0,59	2,0÷2,2	A	1205	C94008	5615	-	AL10x40	
S 955 080 - 16 <i>New</i>	80	22	16	40	50	-	20	6	2	0,63	2,0÷2,2	A	1207	C94008	5615	-	AL10x40	
S 955 100 - 04	100	27	4	48	50	-	24,2	12	6	0,64	1,8÷2,0	A	1102	C93504	5609	-	VBSF12L	
S 955 100 - 05	100	27	5	48	50	-	24,2	12	6	0,68	1,8÷2,0	A	1103	C93505	5609	-	VBSF12L	
S 955 100 - 06	100	27	6	48	50	-	24,2	10	5	0,69	2,0÷2,2	A	1203	C94005	5615	-	VBSF12L	
S 955 100 - 07/08	100	27	7/8	48	50/50,5	-	24,2	10	5	0,73	2,0÷2,2	A	1204/12045	C94006	5615	-	VBSF12L	
S 955 100 - 10	100	27	10	48	50	-	24,2	10	5	0,79	2,0÷2,2	A	1205	C94008	5615	-	VBSF12L	
S 955 100 - 12 <i>New</i>	100	27	12	48	50	-	24,2	10	5	0,85	2,0÷2,2	A	1207	C94010	5615	-	VBSF12L	
S 955 100 - 14 <i>New</i>	100	27	14	48	50	-	24,2	9	3	0,95	2,0÷2,2	A	1205	C94008	5615	-	VBSF12L	
S 955 100 - 16 <i>New</i>	100	27	16	48	50	-	24,2	9	3	1,00	2,0÷2,2	A	1207	C94008	5615	-	VBSF12L	
S 955 125 - 04 <i>New</i>	125	40	4	70	50	-	23,7	12	6	0,95	1,8÷2,0	B	1102	C93504	5609	-	-	
S 955 125 - 05 <i>New</i>	125	40	5	70	50	-	23,7	12	6	0,99	1,8÷2,0	B	1103	C93505	5609	-	-	
S 955 125 - 06	125	40	6	70	50	-	23,7	12	6	1,02	2,0÷2,2	B	1203	C94005	5615	-	-	
S 955 125 - 07/08	125	40	7/8	70	50/50,5	-	23,7	12	6	1,06	2,0÷2,2	B	1204/12045	C94006	5615	-	-	
S 955 125 - 10	125	40	10	70	50	-	23,7	12	6	1,16	2,0÷2,2	B	1205	C94008	5615	-	-	
S 955 125 - 12	125	40	12	70	50	-	23,7	12	6	1,25	2,0÷2,2	B	1207	C94010	5615	-	-	
S 955 125 - 14 <i>New</i>	125	40	14	70	50	-	23,7	12	4	1,35	2,0÷2,2	B	1205	C94008	5615	-	-	
S 955 125 - 16 <i>New</i>	125	40	16	70	50	-	23,7	12	4	1,43	2,0÷2,2	B	1207	C94008	5615	-	-	
S 955 160 - 04 <i>New</i>	160	40	4	70	50	-	41,2	16	8	1,14	1,8÷2,0	B	1102	C93504	5609	-	-	
S 955 160 - 05 <i>New</i>	160	40	5	70	50	-	41,2	16	8	1,21	1,8÷2,0	B	1103	C93505	5609	-	-	
S 955 160 - 06	160	40	6	70	50	-	41,2	16	8	1,41	2,0÷2,2	B	1203	C94005	5615	-	-	
S 955 160 - 07/08	160	40	7/8	70	50/50,5	-	41,2	16	8	1,41	2,0÷2,2	B	1204/12045	C94006	5615	-	-	
S 955 160 - 10	160	40	10	70	50	-	41,2	16	8	1,62	2,0÷2,2	B	1205	C94008	5615	-	-	
S 955 160 - 12	160	40	12	70	50	-	41,2	16	8	1,81	2,0÷2,2	B	1207	C94010	5615	-	-	
S 955 160 - 14 <i>New</i>	160	40	14	70	50	-	41,2	15	5	2,04	2,0÷2,2	B	1205	C94008	5615	-	-	
S 955 160 - 16 <i>New</i>	160	40	16	70	50	-	41,2	15	5	2,23	2,0÷2,2	B	1207	C94008	5615	-	-	

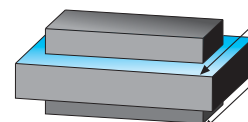
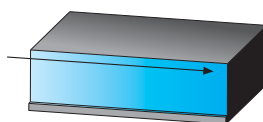
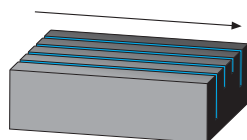

K = Fattore d'avanzamento - Factor of feed - Vorschubfaktor - Facteur d'avance

S 959 ..

Ø 50-80

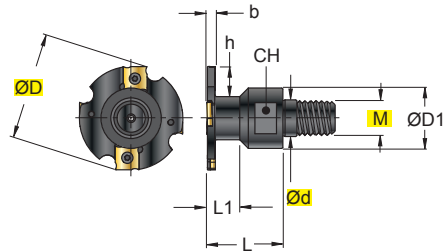

SNHX..
.Z47



SNHX..
.Z52



SNHX..
.Z62



INSERTI - INSERTS
PAG. B 270

(mm)

ART.	ØD	M	Ød	b	ØD1	h	L	L1	Z	K	CH	kg	Nm			
S 959 050 - 04	50	16	17	4	29	14	35	15	4	2	24	0,19	1,8+2,0	1102	C93504	5609
S 959 050 - 05	50	16	17	5	29	14	35	15	4	2	24	0,20	1,8+2,0	1103	C93505	5609
S 959 050 - 06	50	16	17	6	29	14	35	15	4	2	24	0,20	2,0+2,2	1203	C94005	5615
S 959 063 - 04	63	16	17	4	29	14	35	-	8	4	24	0,26	1,8+2,0	1102	C93504	5609
S 959 063 - 05	63	16	17	5	29	14	35	-	8	4	24	0,27	1,8+2,0	1103	C93505	5609
S 959 063 - 06	63	16	17	6	29	14	35	-	6	3	24	0,28	2,0+2,2	1203	C94005	5615
S 959 080 - 04	80	16	17	4	29	22,5	35	-	10	5	24	0,31	1,8+2,0	1102	C93504	5609
S 959 080 - 05	80	16	17	5	29	22,5	35	-	10	5	24	0,32	1,8+2,0	1103	C93505	5609
S 959 080 - 06	80	16	17	6	29	22,5	35	-	8	4	24	0,34	2,0+2,2	1203	C94005	5615

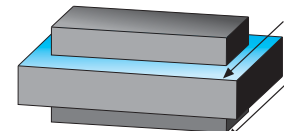
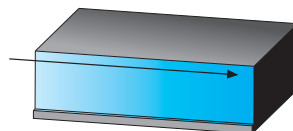
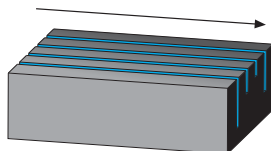

K = Fattore d'avanzamento - Factor of feed - Vorschubfaktor - Facteur d'avance

SCelta VELOCE - QUICK PICK

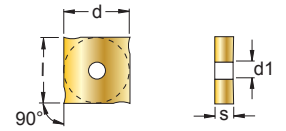

COD.	P			M			K			N			S			H			HT	HW	HC				l	d	s	d1	r	a°
	F	M	R	F	M	R	F	M	R	F	M	R	F	M	R	F	M	R			T115	T528N	T5020	F1035						
SNHX 1102 .Z47							●	●	●	●	●	●	●	●	●	●	●	●	■					11,0	11,0	2,3	4,4	-	-	
SNHX 1103 .Z47							●	●	●	●	●	●	●	●	●	●	●	●	■					11,0	11,0	2,7	4,4	-	-	
SNHX 1203 .Z47							●	●	●	●	●	●	●	●	●	●	●	●	■					12,7	12,7	3,2	5,0	-	-	
SNHX 1204 .Z47							●	●	●	●	●	●	●	●	●	●	●	●	■					12,7	12,7	4,0	5,0	-	-	
SNHX 12045 .Z47							●	●	●	●	●	●	●	●	●	●	●	●	■					12,7	12,7	4,5	5,0	-	-	
SNHX 1205 .Z47							●	●	●	●	●	●	●	●	●	●	●	●	■					12,7	12,7	5,4	5,0	-	-	
SNHX 1207 .Z47							●	●	●	●	●	●	●	●	●	●	●	●	■					12,7	12,7	7,0	5,0	-	-	
SNHX 1102 .Z52		●	●				●	●	●	○	○								■					11,0	11,0	2,3	4,4	-	-	
SNHX 1103 .Z52		●	●				●	●	●	○	○								■					11,0	11,0	2,7	4,4	-	-	
SNHX 1203 .Z52		●	●				●	●	●	○	○								■					12,7	12,7	3,2	5,0	-	-	
SNHX 1204 .Z52		●	●				●	●	●	○	○								■					12,7	12,7	4,0	5,0	-	-	
SNHX 12045 .Z52		●	●				●	●	●	○	○								■					12,7	12,7	4,5	5,0	-	-	
SNHX 1205 .Z52		●	●				●	●	●	○	○								■					12,7	12,7	5,4	5,0	-	-	
SNHX 1207 .Z52		●	●				●	●	●	○	○								■					12,7	12,7	7,0	5,0	-	-	
SNHX 1102 .Z62		●	●				●	●	●	○	○								■					11,0	11,0	2,3	4,4	-	-	
SNHX 1103 .Z62		●	●				●	●	●	○	○								■					11,0	11,0	2,7	4,4	-	-	
SNHX 1203 .Z62		●	●				●	●	●	○	○								■					12,7	12,7	3,2	5,0	-	-	
SNHX 1204 .Z62		●	●				●	●	●	○	○								■					12,7	12,7	4,0	5,0	-	-	
SNHX 12045 .Z62		●	●				●	●	●	○	○								■					12,7	12,7	4,5	5,0	-	-	
SNHX 1205 .Z62		●	●				●	●	●	○	○								■					12,7	12,7	5,4	5,0	-	-	
SNHX 1207 .Z62		●	●				●	●	●	○	○								■					12,7	12,7	7,0	5,0	-	-	

CON ADDUZIONE LUBROREFRIGERANTE - WITH COOLANT SUPPLY

SENZA ADDUZIONE LUBROREFRIGERANTE - WITHOUT COOLANT SUPPLY

MATERIALI - MATERIALS Pag. H 73		VDI 3323 GR.	HB Rm ¹⁾ HRC ²⁾	fz0 mm			Vc m/min Pag. B 254			
				F	M	R	T115	T528N	T5020	F1035
P	ACCIAIO NON LEGATO - NOT ALLOY STEEL	1-5	125-300	0,08	0,12	0,16		220	220	125
	ACCIAIO POCO LEGATO - LOW ALLOY STEEL	6-9	180-350	0,06	0,11	0,15		160	150	120
	ACCIAIO ALTO LEGATO - ALLOY STEEL	10-11	200-325	0,06	0,11	0,15		150	140	100
	INOX MARTENS. - STAINLESS STEEL MART	12-13	200-240	0,05	0,07	0,1		140	150	100
M	INOX AUST. DUPLEX - STAINLESS STEEL AUST	14.1-14.2	180-230	0,05	0,07	0,1		120		90
K	GHISA GRIGIA - GREY CAST IRON	15-16	180-260	0,1	0,14	0,18	120	180	160	
	GHISA SFEROIDALE - SPHEROIDAL GRAPHITE	17-18	160-250	0,08	0,12	0,16	120	160	150	
	GHISA MALLEABILE - MALLEABLE CAST IRON	19-20	130-230	0,08	0,12	0,16	120	170	160	
N	ALLUMINIO E SUE LEGHE - ALUMINIUM	21-25	60-130	0,08	0,12	0,16	1000			
	RAME E SUE LEGHE - COPPER	26-28	90-110	0,06	0,1	0,15	400			
	NON METALLICI - PLASTICS	29-30	/	0,06	0,1	0,15	300			
S	LEGHE RESIST. CALORE - HIG. TEMP. ALLOY	31-35	200-320	0,06	0,08	0,12		40		
	TITANIO E SUE LEGHE - TITANIUM	36-37	400-1050 ³⁾	0,06	0,08	0,12		60		
H	ACCIAIO TEMPRATO - HARDENED STEEL	38-41	45-60 ³⁾							

$$n = \frac{Vc \cdot 1000}{\varnothing D \cdot 3,14} = \text{giri/min (min}^{-1}\text{)}$$

$$fz = fz0 \cdot Kae = \text{mm}$$

$$fn = fz \cdot K = \text{mm}$$

$$Vf = fz \cdot K \cdot n = \text{mm/min}$$

- F = FINITURA, LAV. LEGGERA - FINISHING, LIGHT MACHINING
- M = LAV. MEDIA, GENERICA - MEDIUM MACHINING, GENERIC
- R = SGROSSATURA, LAV. PESANTE - ROUGHING, HEAVY MACHINING

- Vc = m/min VELOCITÀ DI TAGLIO - CUTTING SPEED
- n = giri/min (min⁻¹) NUMERO DI GIRI - NUMBER OF REVOLUTIONS
- fz = mm AVANZAMENTO AL DENTE - TOOTH FEED
- fn = mm AVANZAMENTO AL GIRO - FEED / REVOLUTION
- Vf = mm/min VELOCITÀ DI AVANZAMENTO - FEED SPEED
- Kae = FATTORE DI CORREZIONE - CORRECTION FACTOR

ae/D	0,5-1 50-100%	0,2 20%	0,1 10%	0,05 5%
Vc	Vc (min)-----Vc(max)			
Pag. B 254	R-----M-----F			

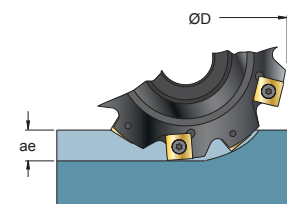

ae/D	0,3 30%	0,2 20%	0,1 10%	0,05 5%	0,02 2%
Kae	1,2	1,5	2,1	3	4,8